

CARDIO COMMAND, INC.

THE ***CARDIO COMMAND, INC.*** TRANSESOPHAGEAL CARDIAC PACING AND RECORDING SYSTEM

CARDIO COMMAND, INC.

Model 7A
Transesophageal Cardiac Stimulator

CARDIO COMMAND, INC.

Model 3
Preamplifier

OPERATOR'S MANUAL

Table of Contents

Introduction	2
Cleaning Instructions	2
Environmental Considerations	2
Year 2000 (Y2K) Compliance	2
Indications	3
Potential Adverse Effects	3
Contraindications	3
Warnings and Precautions	4
Required Components	
CardioCommand Electronics	5
CardioCommand Esophageal Electrodes	6
Preamplifier Front Panel	7
Stimulator Front Panel	8
System Verification	9
System Connections	10
Inserting and Positioning the Esophageal Electrodes	11
Recording and Pacing	12
Pacing with External Generators	13
Device Specifications	14
Service	
Battery Replacement	15
Troubleshooting	16
Warranty	17

Introduction

The CardioCommand Transesophageal Cardiac Pacing and Recording System is intended for temporary atrial pacing and recording in conjunction with any CardioCommand esophageal electrode. This system can be used whenever temporary atrial pacing is indicated, such as electrophysiology studies or intraoperative treatment of bradycardia. Transesophageal pacing also provides a method of inducing cardiac stress during diagnostic procedures such as echocardiography or radionuclide ventriculography without the risks associated with invasive catheterization or drugs such as dobutamine.

Cleaning Instructions

Clean devices using solution of mild soap and water, or bleach diluted 10:1 in water.

Environmental Considerations

CardioCommand Transesophageal Cardiac Pacing and Recording System contains no substances which are harmful to the environment. Batteries should be disposed of properly upon discontinuation of use.

Year 2000 (Y2K) Compliance

CardioCommand products referenced in this manual contain no microprocessors (computer chips). Consequently, there are no risks for malfunction with the year 2000.

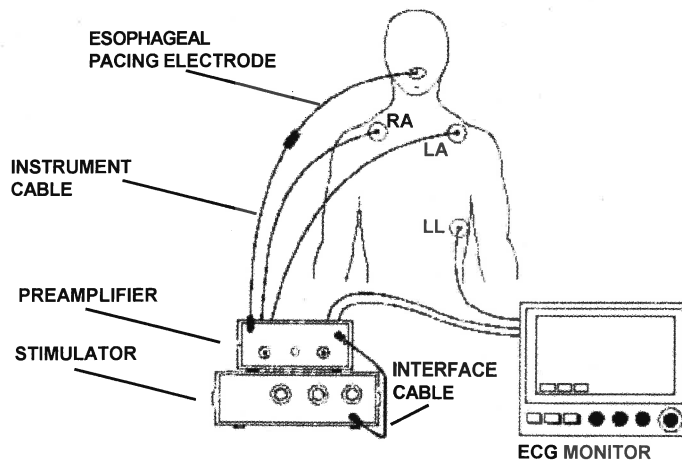

The CardioCommand System works in combination with your existing ECG monitor/recorder.

Indications

The CardioCommand Transesophageal Cardiac Pacing and Recording System, with the appropriate CardioCommand pacing electrode, is indicated for the following:

- Temporary acceleration of heart rate to treat bradycardia.
- Acceleration of heart rate as an alternative to exercise or drugs during diagnostic cardiac studies such as echocardiography or radionuclide ventriculography.
- Antitachycardia pacing for cardioversion of supraventricular tachycardia (SVT, including atrial flutter and re-entrant atrial or atrioventricular paroxysmal tachycardia).
- Esophageal electrocardiography for differential diagnosis of complex atrial arrhythmia.

Potential Adverse Effects

- Inadvertent placement of esophageal electrode in trachea may induce respiratory distress or injury.
- Gagging, choking or nausea may occur with insertion of esophageal catheter.
- If emesis occurs during electrode placement or use, aspiration could result in both respiratory distress and infection.
- During transesophageal pacing, conscious patients may feel discomfort (generally described as “heartburn”) which normally ceases instantly when pacing is discontinued.
- Possible mechanical or electrical injury to the esophageal mucosa may occur if total pacing duration exceeds one hour.
- Unintentional induction of angina may occur during pacing.
- Transesophageal atrial pacing could result in tachyarrhythmia, including atrial flutter, atrial fibrillation ventricular tachycardia, or fibrillation.
- Atrial fibrillation with rapid ventricular response may occur in patients with pre-excitation syndrome.

Contraindications

- Do not use in patients with esophageal injury or disease.
- Do not use as a life supporting or life sustaining device.
- Do not pace for cardioresuscitation in asystolic patients.
- Do not pace patients with complete AV (atrioventricular) heart block.
- Do not pace patients with chronic atrial fibrillation.

Warnings and Precautions

- These devices must be used only on the order of a physician.
- Electrocardiographic and blood pressure monitoring should be used in conjunction with pacing, and defibrillation equipment should be available.
- After insertion of pacing electrodes into patient esophagus, do not allow the lead terminals to come in contact with any conductive surfaces (e.g. wet floor).
- Use of some electrosurgical units can affect the rate of pacing. If esophageal pacing is performed during use of electrosurgical equipment, then physicians are advised to verify maintenance of the desired heart rate. If variations from the paced rate are seen, then pacing should be discontinued during the electrosurgical procedure.
- If defibrillation is necessary, disconnect all patient leads and remove catheter. Resort to an alternative method of patient monitoring while defibrillator is in use.
- Pacing electrode should be removed prior to cardioversion and/or magnetic resonance imaging.
- These devices are intended for transesophageal pacing only. Do not use for intracardiac pacing.

REQUIRED COMPONENTS

CardioCommand Electronics

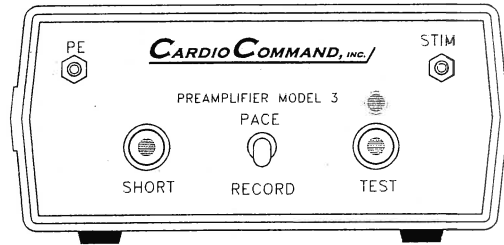

CardioCommand Preamplifier Model 3

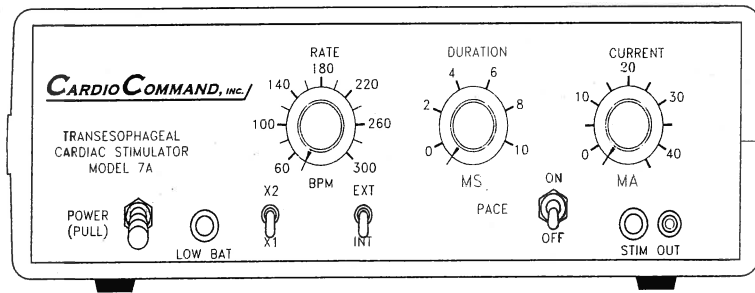

CardioCommand Transesophageal Cardiac Stimulator Model 7A

WITH



Interface Cable

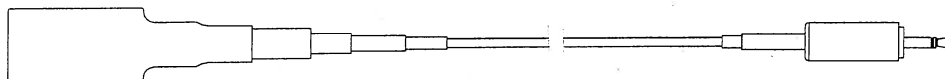

Instrument Cable

CardioCommand Esophageal Electrodes

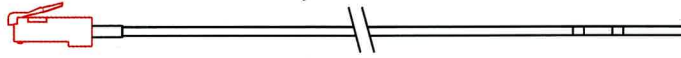

TAPSCOPE® 10 French Esophageal Pacing and Recording Catheter
(with optional stylet)



TAPCATH® 5 French Esophageal Pacing and Recording Catheter

Accessories

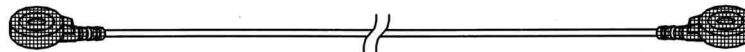

Patient RA and LA Lead Wires (available from CardioCommand)

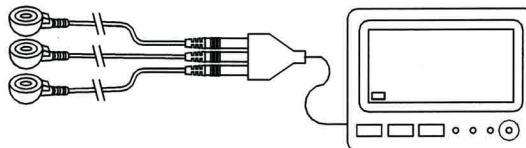

ECG Monitor/Recorder and Leads (not furnished by CardioCommand)

Preamplifier Front Panel

1. PE (Pacing Electrode jack). One end of the Instrument Cable will be inserted here. The other end will be connected to the pacing electrode.
2. STIM. One end of the Interface Cable will be inserted here. The other end will be connected to the output jack of the Stimulator (OUT).
3. SHORT. Depressing this button restores an adequate ECG tracing after pacing, eliminating the effect of polarization.
4. PACE/RECORD. In the RECORD position, the ECG monitor will display the esophageal ECG. In the PACE position, the monitor will display surface Lead I. This switch must be in the PACE position during pacing.
5. TEST. When this button is pressed, a green light indicates battery power is adequate for operation of Preamplifier.

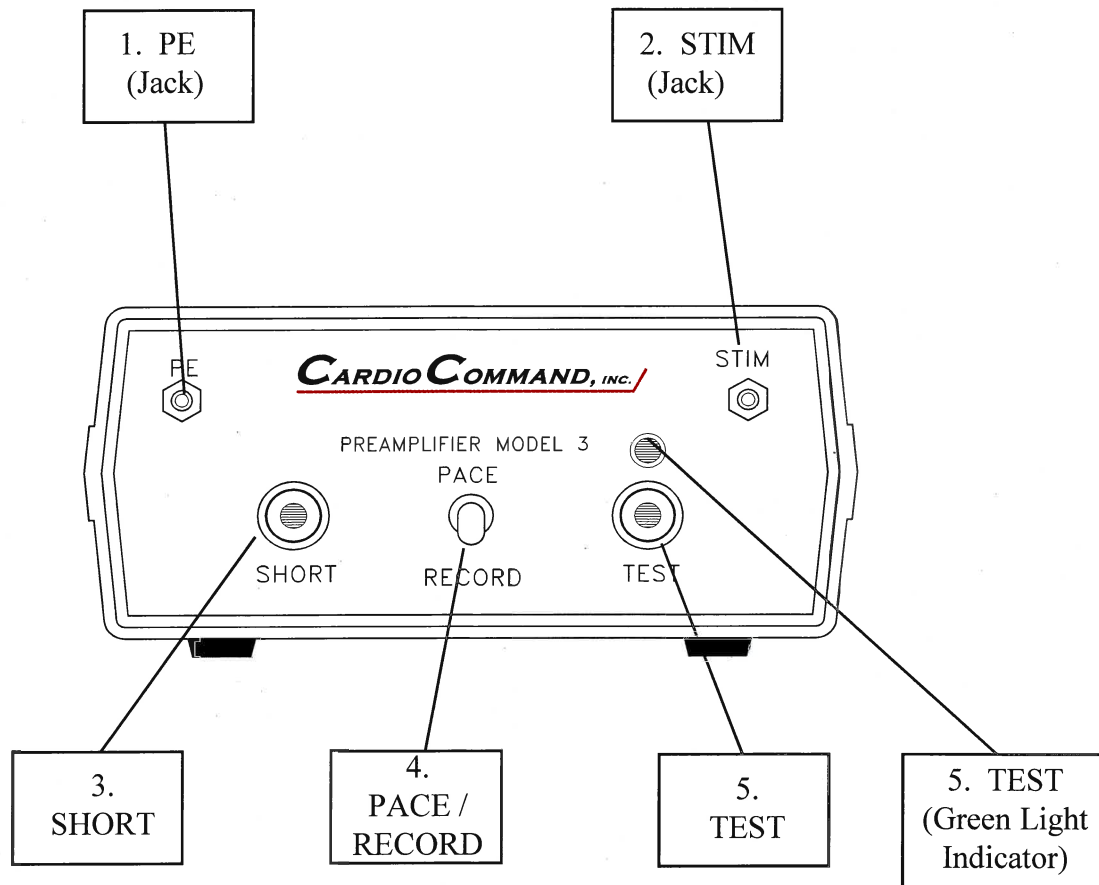

Stimulator Front Panel

1. RATE. Sets pacing rate of stimulator output (beats per minute, BPM).
2. DURATION. Sets pulse width of stimulator output (milliseconds, ms).
3. CURRENT. Sets amplitude of output current (milliamps, mA).
4. POWER. Turns Stimulator ON and OFF.
5. LOW BAT. Yellow indicator light flashes once when POWER is turned ON, and remains illuminated when batteries need replacement.
6. X1/X2. In X1 position, the pacing rate will be as set by the RATE knob. The pacing rate doubles while the switch is held in the X2 position.
7. EXT/INT. Set to INT position for normal operation. Set to EXT position only if using an external pulse generator.
8. PACE. Switches Stimulator into pacing mode (ON position).
9. STIM. Red light flashes with each pulse output during pacing.
10. OUT. Stimulator output. Interface Cable will be inserted here and the other end connected to STIM jack of Preamplifier.

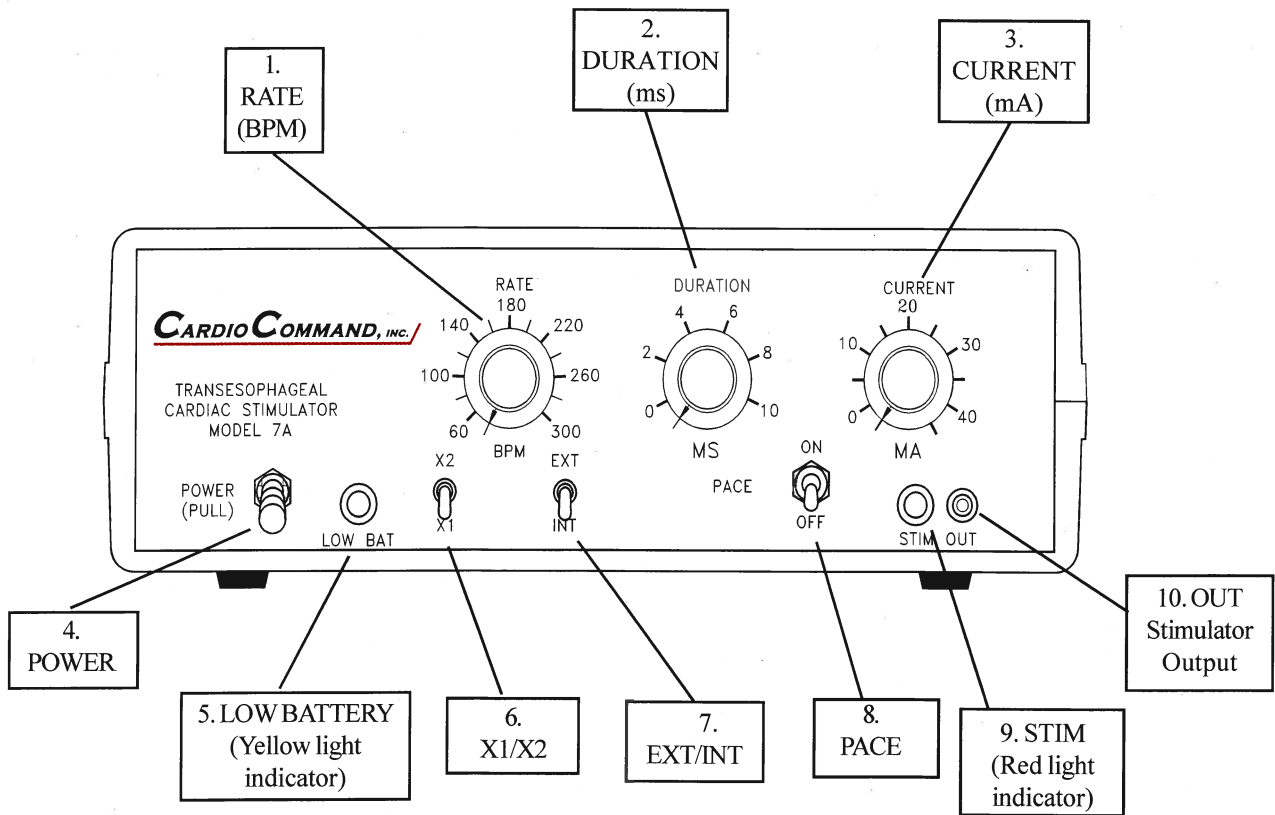

System Verification

BEFORE EACH USE, PERFORM THE FOLLOWING STEPS:

1. **Disconnect** Interface Cable from the OUT jack of the Stimulator. **The following procedure will not work properly with this cable connected to the Stimulator.**
2. Depress the TEST button on front panel of Preamplifier. The green indicator light should flash on. If it does not, replace batteries and press TEST again. If replacing batteries does not correct the problem, contact Customer Service.
3. Turn Stimulator POWER switch on. (Pull it out and push up.) The yellow LOW BAT indicator light should flash once, indicating that battery power is adequate for operation. If LOW BAT does not flash or remains illuminated, then turn POWER off and replace the batteries.
4. Put EXT/INT switch to INT. Set RATE to 60 BPM, DURATION to 10 ms and CURRENT to 20 mA.
5. Turn PACE switch to ON. Confirm that the red STIM light is flashing at approximately the set rate. If STIM light is not flashing at set rate or flashes in an erratic manner, contact Customer Service.
6. Set the PACE/RECORD switch of Preamplifiers to PACE position. Connect the Interface Cable between the Stimulator and Preamplifier and confirm that the STIM light is **NOT** flashing. If STIM is flashing, contact Customer Service.
7. After Verification, turn POWER and PACE switches off and turn all knobs fully counterclockwise.

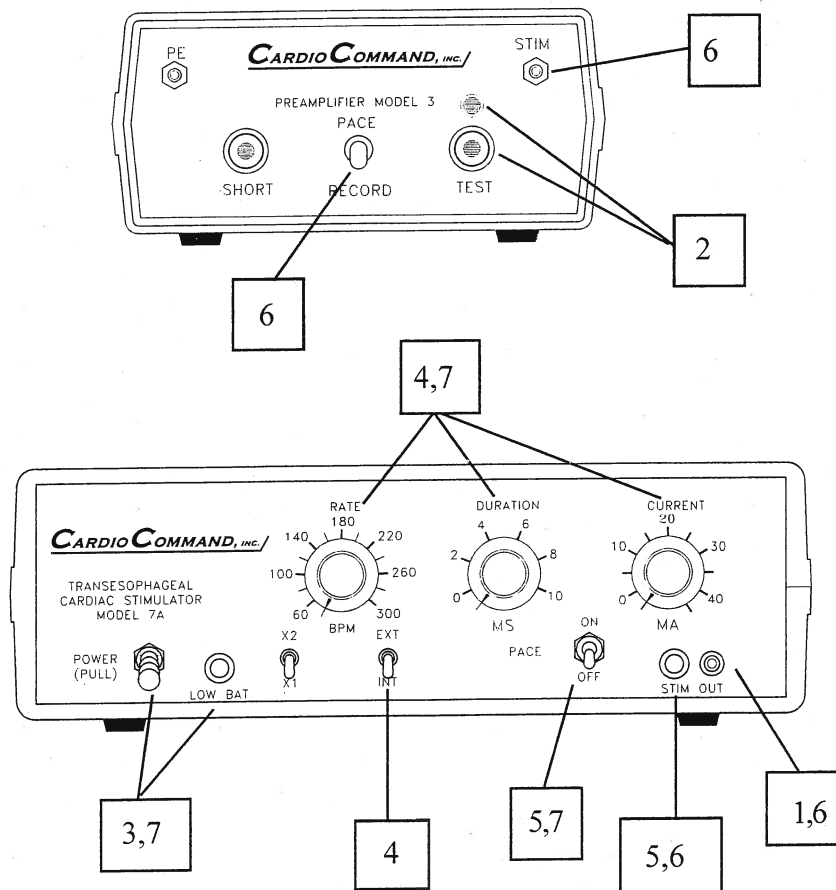

System Connections

NOTE: Before making system connections, perform System Verification. Before making any connections to the patient, ensure all knobs are turned fully counterclockwise and all switches are in their downward positions. Set Pre-amplifier PACE/RECORD switch to RECORD.

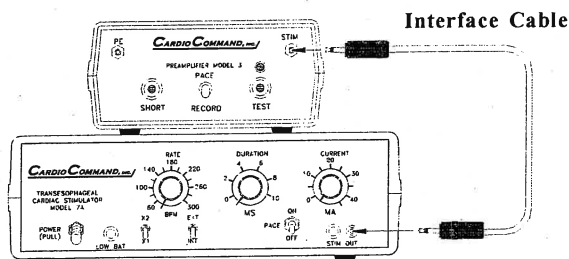

1. Plug one end of Interface Cable into the OUT jack of Stimulator and other end into STIM jack of Pre-amplifier.

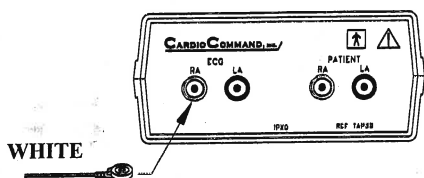

2. Connect the ECG RA Lead (normally connected to patient's RA surface electrode) to the RA ECG terminal on rear of the Pre-amplifier.

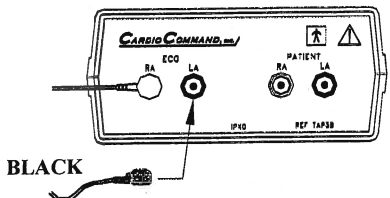

3. Connect the ECG LA Lead (normally connected to patient's LA surface electrode) to the LA ECG terminal on rear of the Pre-amplifier.

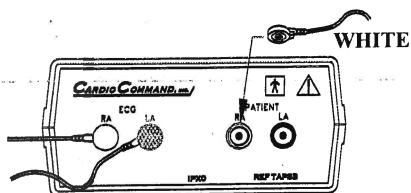

4. Connect CardioCommand white RA Lead to patient's RA surface electrode and to the RA PATIENT terminal on rear of the Pre-amplifier. Lead wires provided are for disposable electrodes with snap lead connections.

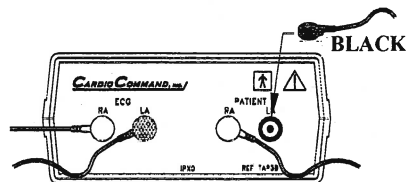

5. Connect CardioCommand black LA Lead to patient's LA surface electrode and to the LA PATIENT terminal on rear of the Pre-amplifier.

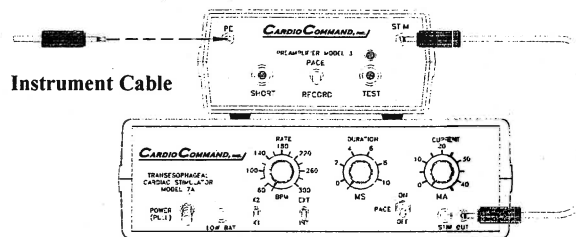

6. Connect Instrument Cable to the PE (Pacing Electrode) jack on front panel of Pre-amplifier.



7. After insertion into patient's esophagus, connect Pacing Electrode to Instrument Cable.

WHEN USED IN OPERATING ROOM:

If a surgical patient is to be connected to the CardioCommand Pacing and Recording System, the longer ECG leads furnished by CardioCommand should be attached to the patient RA and LA surface electrodes at the time the electrodes are placed. In the operating room, these lead wires will be attached to the RA and LA PATIENT terminals on the Pre-amplifier. Connecting the longer lead wires in advance, **even if the patient is in a holding area and not yet in surgery**, eliminates the inconvenience of switching from shorter ECG leads to the CardioCommand leads later. You will see a surface tracing without the pacing electrode.

Inserting and Positioning the Esophageal Electrodes

- A. Before inserting catheter, complete the System Verification and System Connections. Ensure that Stimulator POWER is off and CURRENT is set to 0 mA.
- B. Lubricate the catheter, taking care not to coat the electrodes. In conscious patients, 2-3 sprays of a topical analgesic may facilitate catheter insertion. Insert catheter into esophagus using conventional oral or nasal techniques.
- C. CardioCommand esophageal catheters have markings indicating depth of insertion (DOI) in cm. The capture threshold for pacing varies with the distance between the electrodes and left atrium. The optimal range of DOI for minimizing capture threshold and any discomfort experienced during pacing by conscious patients can be approximated using Patient Height (D) or by maximizing P-wave amplitude of the Esophageal ECG (E).
- D. **Patient Height:** For oral insertion in adults, the DOI for atrial pacing can be approximated as:

$$\text{DOI (cm)} = \text{patient height (cm)} / 5, \text{ or height (inches)} / 2$$
 Atrial capture can be attained for most patients within a range of ± 3 cm of this DOI. For nasal insertion of the catheter, an additional 3-4 cm should be used.
- E. **Esophageal ECG:** Electrode position can be optimized for atrial pacing as follows:
 - 1) Insert electrodes to an initial DOI = Height/5 + 5 cm (oral) or Height/5 + 9 cm (nasal).
 - 2) Connect electrode to Instrument Cable and switch Preamplifier to RECORD mode.
 - 3) Set ECG Monitor to display Lead I and gradually withdraw catheter while monitoring esophageal ECG. DOI which maximizes P-wave amplitude is optimal for atrial pacing.
- F. **Positioning Electrodes without Esophageal ECG using Pacing Stimulus:**
 - 1) Insert electrodes to an initial DOI = Height/5 + 5 cm (oral) or Height/5 + 9 cm (nasal).
 - 2) Gradually increase CURRENT until atrial capture or 20 mA is achieved. (Note: If yellow STIM light is not flashing, check System Connections.)
 - 3) If capture is not achieved, slowly withdraw catheter while monitoring ECG for atrial pacing.
 - 4) If capture is not achieved after withdrawing catheter 10 cm, reduce CURRENT to 0 mA and repeat steps 1-3 for CURRENT = 20-40 mA.
 - 5) Once capture is attained in conscious patients, slowly decrease CURRENT until capture is lost. Pacing will be more comfortable with CURRENT slightly above this atrial threshold level.
- G. Once electrodes are positioned for atrial pacing, secure catheter to patient's chin with tape.

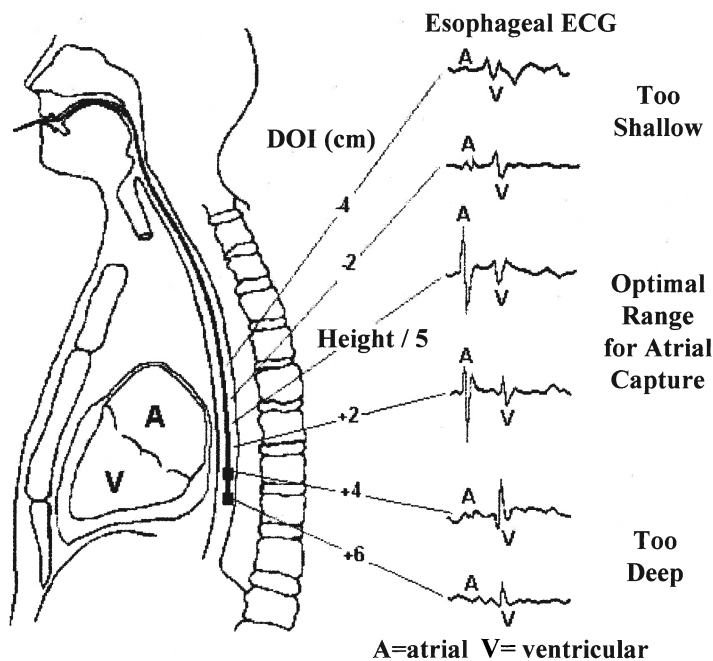

Recording and Pacing

1. Recording

- A. When a three channel ECG Monitor is being used, set it to display Leads I, II, III on Channels 1, 2, and 3. With the Preamplifier set in the RECORD mode:
Channel 1 will display an esophageal ECG tracing with an amplified P-Wave.
Channel 2 will display a surface tracing.
Channel 3 will display a composite esophageal/surface tracing.
- B. When a single channel Monitor is used, set it to display Lead I if an esophageal tracing is desired, or on Lead II if a surface tracing is desired. If, after positioning the pacing electrode in the optimum position, a surface tracing is desired, switch the ECG Monitor to Lead II; this will not affect pacing capability. Check Lead I periodically to confirm electrode positioning. One cm displacements of pacing electrode may affect the current output needed for atrial capture.

2. Pacing

A. Set-Up

1. Turn Stimulator POWER switch to on, and the EXT/INT switch to INT.
2. Set the Stimulator as follows:
RATE At least 12 BPM above patient's resting heart rate
DURATION 10 ms
CURRENT 0 mA

B. Capture

1. Set the Preamplifier PACE/RECORD switch to PACE.
The ECG Monitor will display a tracing from the surface electrode.
2. Turn PACE switch on Stimulator to ON position.
3. Increase CURRENT in steps of 5 mA, pausing at each step to determine if capture is attained, as evidenced by a 1:1 relationship between the pacing spike and QRS of the ECG.
4. Once capture is attained, increase patient's heart rate by turning RATE to desired setting.
CURRENT should not be changed until pacing is terminated or capture is lost. If capture is lost, turn Stimulator PACE switch to OFF, reduce CURRENT to 0 mA and repeat steps 1,2 and 3.

NOTE: Do not pace continuously for more than one hour. In conscious patients undergoing diagnostic procedures, pacing periods should last no longer than 3 minutes each in order to minimize discomfort. Total pacing duration should not exceed 12 minutes unless, in the physician's judgment, a longer pacing period is required. **If yellow LOW BAT indicator light comes on during use, replace batteries as soon as possible. Extended operation may result in erratic output.**

C. Termination

1. At end of procedure, turn PACE switch to OFF and POWER to off (down).
2. Turn all control knobs fully counterclockwise.
3. Disconnect the esophageal pacing electrode from the Instrument Cable.
4. Withdraw electrode and dispose immediately according to standard hospital procedure.
5. Disconnect the patient from the RA and LA leads.

Pacing with External Generators

1. Before connecting an external generator to the CardioCommand System, run a brief pacing trial. (Follow the instructions for System Verification, System Connections, Inserting and Positioning the Esophageal Electrodes, Recording and Pacing.) This will determine the proper current level and pulse duration for achieving capture. It will also help assure conscious patient compliance by familiarizing the patient with the pacing sensation.
2. Connect the anode (+) of the external generator to the red (+) EXTERNAL INPUT jack located on the back panel of the Stimulator. Connect the cathode (-) of the external generator to the black (-) EXTERNAL INPUT jack on the back panel of the Stimulator. The jacks accommodate either banana plugs or pins. Pins are inserted into the hole at the top of the jack and secured by tightening the plastic turret.
3. Set the CURRENT and DURATION knobs counterclockwise to zero. The RATE dial will not be functional as rate will be controlled by the external generator.
4. Set the external generator controls as follows:

Pulse Duration	1ms
Voltage/Current	5V/5 mA
Rate	Desired setting (as determined in pacing trial)
5. Set the Stimulator DURATION to the desired pulse width and place EXT/INT switch in EXT position.
6. Turn Stimulator POWER switch on, turn PACE switch to ON and slowly increase Stimulator CURRENT until capture is achieved.
7. To terminate external pacing, refer to Pacing Termination procedure.

Device Specifications

CardioCommand Preamplifier MODEL 3

Electrical

Amplifier: Input impedance greater than 500 kilo-ohms at 10 Hz
Differential input gain of 2

Physical

Size: 2.375" (6 cm) high x 6.375" (16.2 cm) deep x 5.125" (13 cm) wide
Weight: 1 lb (0.45 kg)
Material: Impact-resistant ABS (acrylonitrile, butadiene, styrene) plastic enclosure

Power Supply Battery type: 9-volt alkaline (2)

Battery Life The unit should operate normally for 3 years with fully charged batteries at the specified operating conditions.

CardioCommand Transesophageal Cardiac Stimulator MODEL 7A

Electrical

Amplitude: Continuously variable, 0-40 mA
Pacing rate: Continuously variable, 60-300 BPM (X1) 120-600 BPM (X2)
Pulse width: Continuously variable rectangular pulse, 0-10 ms
Load impedance: Constant current at impedances up to 4 kilo-ohms at 20 mA.
Accuracy: $\pm 10\%$ of full scale.

Physical

Size: 2.625" (6.7 cm) high x 7.75" (19.7 cm) deep x 8.125" (20.6 cm) wide
Weight: 2.25 lbs (1 kg)
Material: Impact-resistant ABS plastic enclosure

Power Supply Battery type: 9-volt alkaline (4)

Battery Life The unit should operate normally for 24 hours with fully charged batteries at the specified operating conditions.

The device should operate normally for 2 hours upon activation of the yellow LOW BAT indicator.

Warning: Use of batteries other than those specified by the manufacturer may result in the device not operating within the stated specifications.

The Preamplifier Model 3 and Transesophageal Cardiac Stimulator Model 7A are IEC Class BF Equipment.

Service

Warning: Remove all batteries if the device is not to be used for extended periods of time.

Battery Replacement, Preamplifier

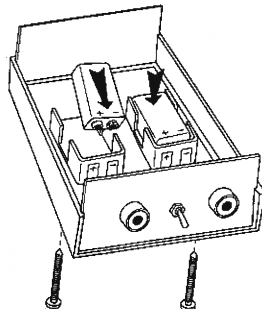

1. Remove the two screws located on the bottom of the Preamplifier and remove the cover.
2. Remove the two 9-volt batteries located inside the unit and replace them with new batteries. Be sure to follow the polarity diagram on the inside of the battery casing.
3. Replace the cover and attach it with the two screws.
4. Press the TEST button. If the green indicator still fails to light, contact Customer Service.

Battery Replacement, Stimulator

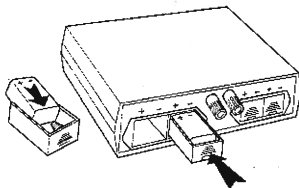

1. Always disconnect the patient from the Stimulator before replacing batteries.
2. Withdraw each battery holder by lifting and then pulling out.
3. Remove the old batteries and replace them with new batteries. Be sure to follow the polarity diagram on the inside of the battery holders.
4. Verify proper operation before pacing a patient by performing the System Verification. If the STIM light does not flash, check to be sure the polarity is correct. If polarity is correct and the STIM light does not flash properly or LOW BAT light remains illuminated, contact Customer Service.

CardioCommand recommends that this device be serviced by trained and authorized service personnel only. Contact the CardioCommand Customer Service Department to request repair services.

CardioCommand, Inc.
4920 W. Cypress St., Ste. 110
Tampa, FL 33607 U.S.

(800) 231-6370 (U.S.) or (813) 289-5555
Fax (813) 289-5454

www.cardiocommand.com

Trouble Shooting

Problem: Stimulator output light (STIM) does not flash when performing System Verification.

- Solution:
- Verify Stimulator POWER is switched on (up) and PACE switch is ON.
 - Ensure EXT/INT is set to INT.
 - Verify that DURATION is at 10 msec and CURRENT at 20 mA
 - Ensure Stimulator/Preamplifier Interface Cable is not connected.
 - Check batteries.

Problem: Unable to obtain an esophageal ECG tracing.

- Solution:
- Ensure Preamplifier RECORD/PACE switch is in RECORD position.
 - Ensure ECG monitor is set to display Lead I.
 - Check surface electrodes and ECG patient leads.
 - Check all cables and connectors.
 - Check Preamplifier batteries.
 - Attempt recording with a new esophageal electrode.

Problem: ECG base line is not stable after switching from PACE to RECORD.

- Solution:
- Depress Preamplifier SHORT button for 5-10 sec.

Problem: After setting all the dials on the Stimulator you do not see pacing artifact on the monitor or do not achieve capture.

- Solution:
- Is STIM light on Stimulator front panel flashing at the pacing RATE?
 - Yes:
 - Ensure that pacing RATE is at least 12 BPM above the patient's resting heart rate.
 - Verify electrode positioning by reference to the esophageal ECG or patient height.
 - No:
 - Ensure Preamplifier RECORD/PACE switch is in PACE position.
 - Ensure that Interface and Instrument Cables are properly connected.
 - Ensure that Stimulator EXT/INT switch is set to INT.
 - Ensure that Stimulator POWER and PACE switches are ON (up positions).
 - If still unable to achieve capture, attempt pacing with a new esophageal electrode.

Problem: Low battery indicator is illuminated.

- Solution:
- Replace batteries.

Problem: Erratic output.

- Solution:
- Replace batteries.

Problem: Artifact obscuring esophageal ECG tracing.

- Solution:
- Check all surfaces leads. Check all cable connections.

Warranty

For a period of one year, CardioCommand warrants that these products, when used in accordance with the directions in CardioCommand's labeling, are fit for the purposes and indications described in the labeling. **UNLESS THE PRODUCTS ARE USED IN ACCORDANCE WITH SUCH INSTRUCTIONS, THIS WARRANTY, AND ALL OTHER EXPRESSED OR IMPLIED WARRANTIES, INCLUDING ANY WARRANTY OF MERCHANTABILITY OR FITNESS FOR A PARTICULAR PURPOSE, ARE VOID AND OF NO EFFECT.** CardioCommand's sole obligation under this warranty shall be, at its option, to repair or replace the product. In no event shall CardioCommand be liable for incidental or consequential damages.

CARDIOCOMMAND, INC.

4920 W. Cypress St., Ste. 110
Tampa, Florida 33607 U.S.

Phone: (813) 289-5555
(800) 231-6370 (U.S. only)

Fax: (813) 289-5454

Visit our website at
<http://www.cardiocommand.com>